

Datasheet

TZ/OBC Transponder



Description

Designed to work with Sonardyne's TZ/OBC acoustic positioning system, the Type 7815-000-06 transponder enables the positions of seismic hydrophone positions to be accurately and efficiently determined.

Prior to deployment from a cable lay boat, the transponders are attached to the seismic cable at each ground station, typically every 50 metres. Once the bottom cable is laid, the acoustic system measures the ranges from the surface transceiver to the transponders to enable their exact positions to be established. This positioning process can either be conducted while laying the cable or later while shooting.

The transponders are small and lightweight and have been proven to be able to withstand the demanding and varied operational environment of OBC and TZ surveys.

Standard features include a depth rating of 500 metres, a unique acoustic 'address' enabling thousands of units to be laid in a single deployment and automatic battery voltage monitoring to allow users to better plan their maintenance schedules.

In OBC operations using a 'squirter' cable deployment system, 'carapaces' are available that provide a fast and secure means of attaching transponders to the cable. The carapaces are manufactured from tough plastic that encapsulates the transponder and optional RFID asset tracking tag, clamping it securely to the cable whilst protecting it from the high cable deployment and recovery speeds.

The carapace design which is now in use with many crews around the world has been proven to be easy to fit and reduces long term maintenance when compared with traditional tie-wrap and tape methods. The low profile shape of the carapace also reduces the risk of snagging and as it is acoustically 'quieter' in the water, creates less noise interference down the cable.

Key Features

- Versatile, low cost transponder
- Depth rated to 500 Metres
- Provides fast and efficient positioning of OBC cables
- Compact and rugged design
- HF frequency band from 35-55kHz
- Alkaline battery packs give up to 18 months listening life
- Optional RFID tags for asset tracking

Specifications

TZ/OBC Transponder

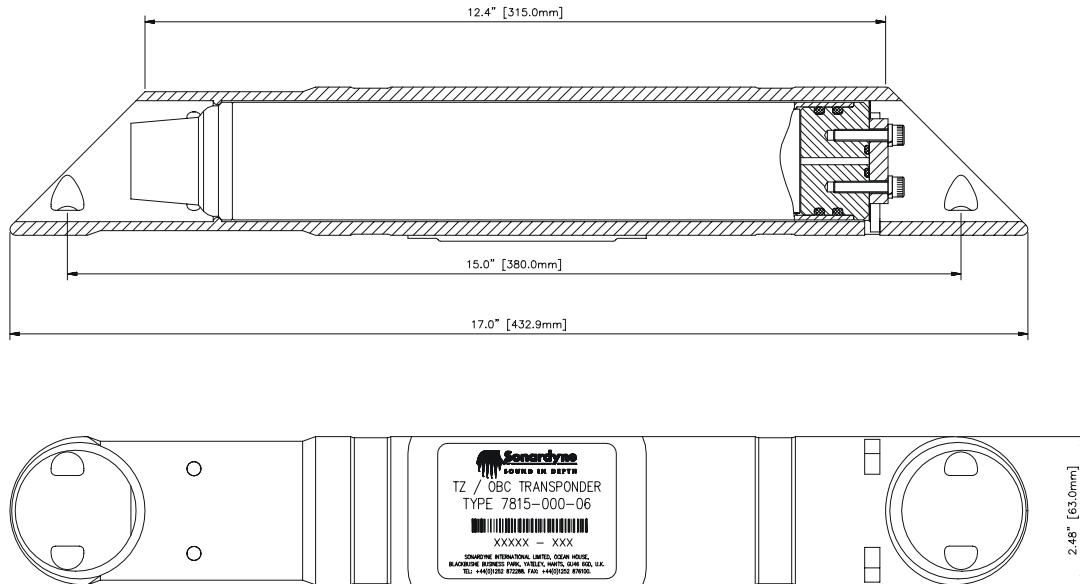

Feature	Type 7815
Depth Rating	500 Metres
Operating Frequency Range	HF (35–50kHz)
Source Level	184-187dB
Receive Sensitivity	105-115dB re 1µPa @1m
Number of Unique Addresses	3609 (Field Programmable)
Switch On	Continuously operating (No On/Off switch)
Battery Life	Alkaline: 18 months
Mechanical Construction	Plastic and Aluminium Alloy (Anodised)
Dimensions (LxDia)	442mm (17.4") x 63mm (2.4")
Weight in Air	1.1Kg
Weight in Water	0.75Kg
Deck Unit	Type 7967-000-02 (Includes transducer and 10 metres of cable)